

Product Group Flow Meters.

Product Category Process Control.

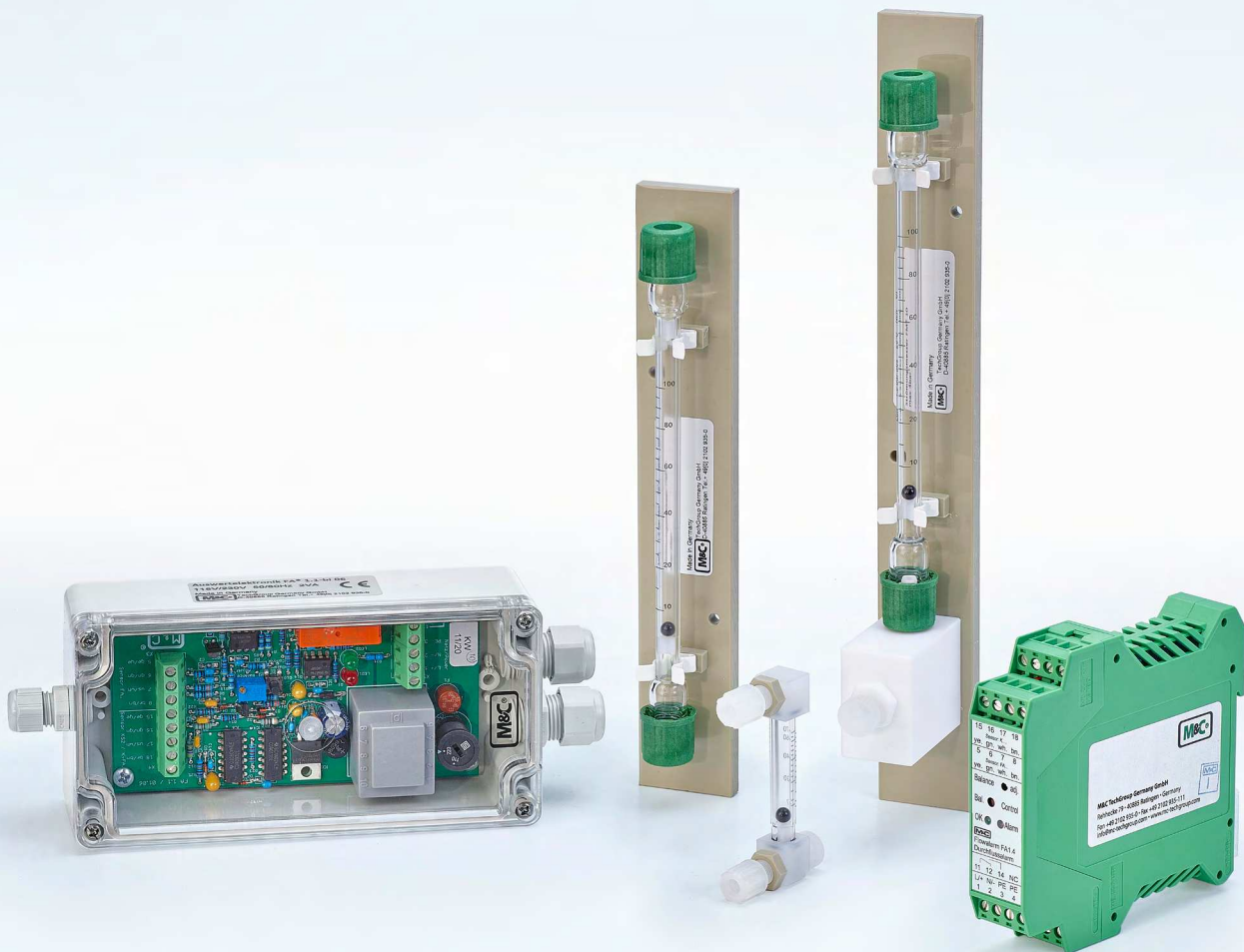

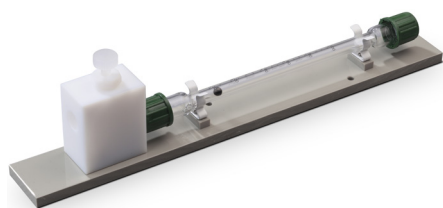

FM-10/100

Float-Type Flow Meter Series FM®

Versions FM-1, FM-10

Special Features

- Available with different measuring ranges from 10 to 800 NI/h air
- High chemical resistance
- For gases and liquids
- Easy dismantling and cleaning
- Also with high-precision needle valve
- Even for high sample gas and ambient temperatures up to 150 °C [302 °F] available

Application

The M&C flow meters – type FM-1 and FM-10 – which are highly corrosion-resistant are used for controlling the flow in the case of aggressive gases and liquids. The measuring tube is delivered according to your specific operating data, e.g. medium, temperature, pressure.

- For connecting the tubes, a special range of connecting fittings is available. Please see separate data sheet "Fittings for GL Glass Connections".

Description

The FM-1 and FM-10 float-type flow meters consist of an upright glass tube conically widening inside towards the top, in which a floating ball can move freely up and down. The medium flows from the bottom to the top through the tube and lifts the floating body until there is a ring-shaped gap between the tube wall and the floating ball so that the forces acting on the body are in equilibrium. Each height position of the floating ball corresponds to a certain flow rate, which can then be read on a calibrated scale.

Sealing and connecting points have been reduced in design down to the inlet and outlet connections. All parts in contact with the medium are made of glass or PTFE.

The flow meters can be dismantled in a few simple steps and are therefore easy to clean. The FM-10 flow meter is supplied with a fine adjustment valve at the inlet for precise flow value adjustment.

- For automatic flow monitoring, the optical control unit types FA... are used. Please see separate data sheets "Optical Bi-Stable Flow Alarm Sensors Series FA®", "Electronic Controller Series FA®" and "Optical Flow Monitoring Series FA®".

Flow meter FM-1

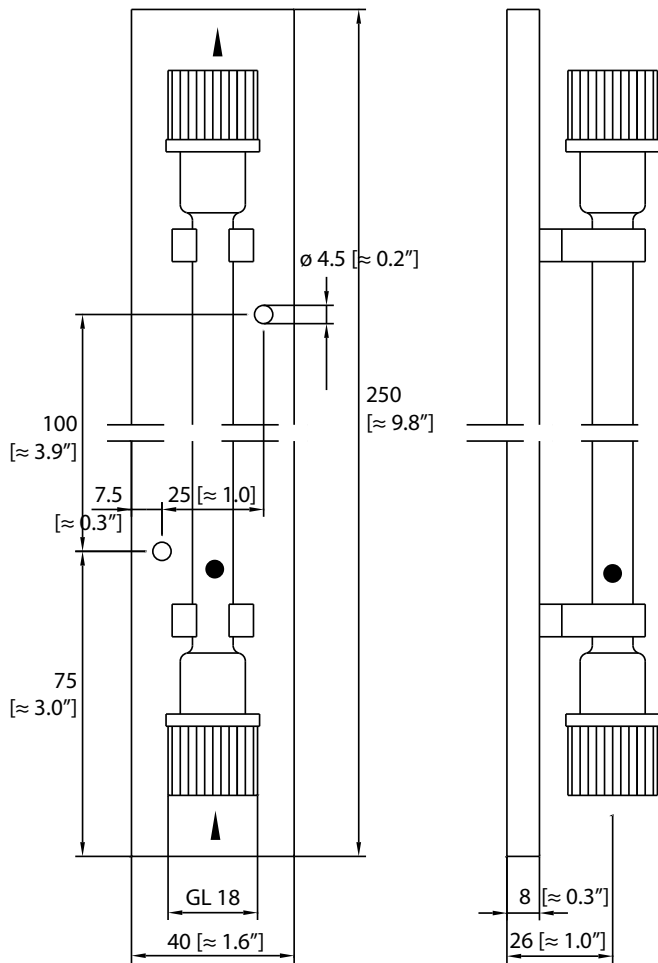

Flow meter with needle valve in the inlet FM-10

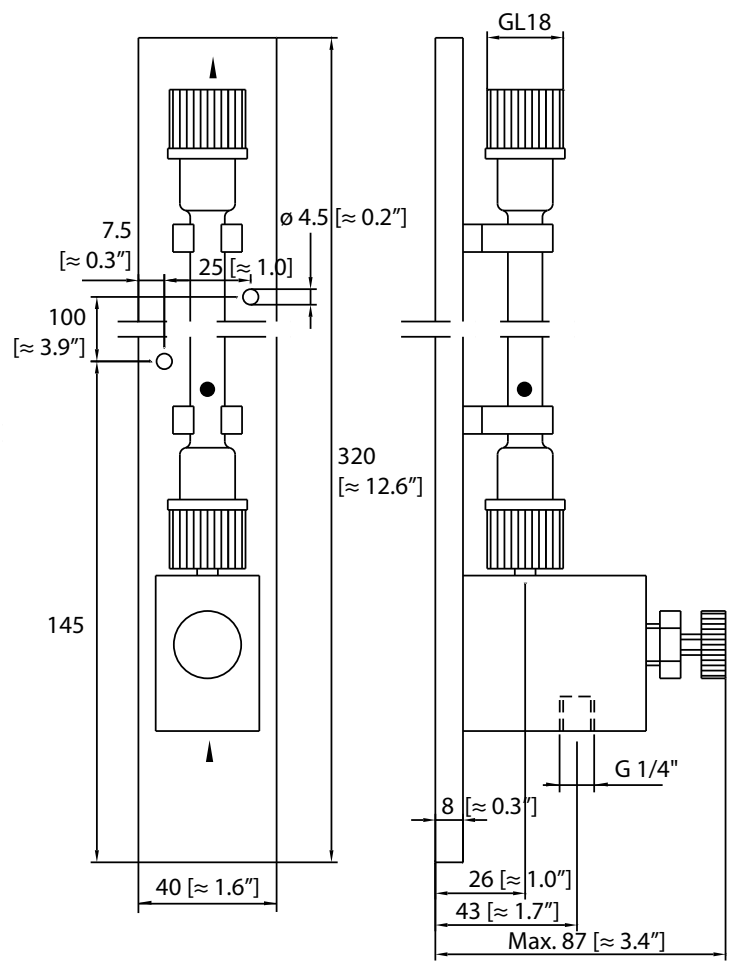

Dimensions in mm [Inches]

Flow Meter	FM-1	FM-1-H	FM-10	FM-10-H
Needle valve in the inlet	No		Yes	
Standard maximum measuring values calibrated at 1.2 bar; 20 °C [68 °F]..NI/h air:	Flow meter types on stock are underlined:			
NI/h water:	16	40	60	<u>100</u> <u>250</u> <u>500</u> <u>800</u>
Flow rate ...NI/h air at 20 °C [68 °F]; 1.2 bar	2.5	5	12	25 40 60 100*
Scale of measurement	10 : 1			
Accuracy class	2.5 %			
Scale	Length of the scale 100 mm, calibrated in NI/h			
Pressure at 20 °C [68 °F]	Max. 4 bar g			
Sample temperature, max.	+80 °C [176 °F]	+150 °C [302 °F]	+80 °C [176 °F]	+150 °C [302 °F]
Ambient temperature, max.	+60 °C [140 °F]	+150 °C [302 °F]	+60 °C [140 °F]	+150 °C [302 °F]
Storage temperature	-25 to +80 °C [-13 to 176 °F]			
Sample gas connections, INLET	GL 18 - ø 6, standard (optionally: ø 8, ø 10)		G 1/4" i DIN ISO 228/1**	
Sample gas connections, OUTLET	GL 18 - ø 6, standard (optionally: ø 8, ø 10)		GL 18 - ø 6, standard (optionally: ø 8, ø 10)	
Method and position of mounting	Wall-mounting/vertical			
Materials of sample-contacting parts	Glass, PTFE		Glass, PTFE, PCTFE	Glass, PTFE, PEEK
Dimensions (H x W x D)	250 x 40 x 40 mm [≈ 9.8" x 1.6" x 1.6"]		320 x 40 x 84 mm [≈ 12.6" x 1.6" x 3.3"]	
Weight	130 g [≈ 0.3 lb]	280 g [≈ 0.6 lb]	300 g [≈ 0.7 lb]	440 g [≈ 1.0 lb]

* Floating ball out of Hastelloy® C (a registered trademark used by Haynes International, USA)

** The dimensions and designation of the screw-in threads correspond to the respective applicable standard. The tolerances of the thread standards are matched to metal threads and cannot be applied to plastic threads.

Part Numbers of the Flow Meter Types on Stock

Measuring range	FM-1	FM-1-H	FM-10	FM-10-H
Flow meter types on stock	Part No.	Part No.	Part No.	Part No.
10 - 100 NI/h air	09F1000	09F1100	09F1500	09F1550
25 - 250 NI/h air	09F1010		09F1510	
50 - 500 NI/h air	09F1020		09F1520	
80 - 800 NI/h air	09F1030		09F1530	
Option:	09F9000 for special measuring range and special calibration.			

If other versions are required, please order in detail, e.g. flow meter FM-1, 6-60 NI/h air, 20 °C, 1.2 bar

Please note: NI/h and NI/min refer to the German standard DIN 1343 and are based on these standard conditions: 0 °C [32 °F], 1013 mbar.

Please specify in your order:

Measuring range: ... NI/h;
Medium: ... ;
Pressure: ... bar;
Temperature: ... °C

E.g. flow meter FM-10; 7-70 NI/h chlorine; 20 °C; 1.2 bar



FM40

Float-Type Flow Meter Series FM®

Version FM40 for front-panel mounting

Special Features

- High chemical resistance
- Compact, flat design
- With fine-control needle valve
- With integrated tube connections DN 4/6

Application

The compact, flat, corrosion-resistant FM40 flow meter for front-panel mounting is used for flow control of gas media in analysis devices and systems.

Description

The FM40 float-type flow meter consists of an upright glass tube conically widening inside towards the top, in which a floating ball can move freely up and down, and of the head and bottom parts with an integrated PVDF needle valve. The basic body for fixing the head and foot sections is the max. 4 mm deep "front panel" with two corresponding mounting holes.

The medium flows from the bottom to the top through the tube and lifts the floating ball until there is a ring-shaped gap between the tube wall and the floating ball so that the forces acting on the body are in equilibrium. Each position of the floating ball (depending on the measuring range either made of glass or Hastelloy® C) corresponds to a certain flow rate which is then visible on a calibrated scale.

The measuring tube is sealed with O-rings in the head and foot sections, as is the fine-control needle valve.

The parts in contact with the medium are made of PVDF, FPM and glass. The flow meter is equipped with a fine-control valve at the inlet for precise flow rate adjustment. In addition, the FA1bi optical monitoring unit is used for automatic flow monitoring.
– See separate data sheets "Optical Bi-Stable Flow Alarm Sensors Series FA®" and "Electronic Controller Series FA®" –

Flow meter FM40

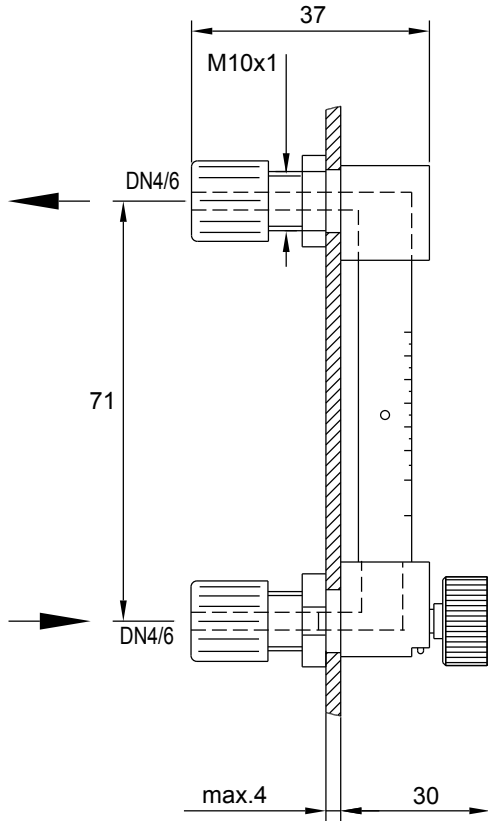

Dimensions in mm

Technical Data

Flow Meter	FM 40
Measuring range calibrated at 1 bar abs., 20 °C [68 °F]	7-70 NI/h air, Part No. 09F4000 15-150 NI/h air, Part No. 09F4005 25-250 NI/h air, Part No. 09F4010 50-500 NI/h air, Part No. 09F4015
Scale of measurement	10:1
Accuracy class	6 %
Scale	Calibrated in NI/h
Scale length	Approx. 30 mm
Pressure max.	3 bar abs.
Temperature max.	60 °C [140 °F]
Connections	Tube connectors DN 4/6
Material used for parts in contact with medium	PVDF, glass, Hastelloy® C4, FPM

Hastelloy® is a registered brand name of Haynes International Inc., USA.

Please note: NI/h and NI/min refer to the German standard DIN 1343 and are based on these standard conditions: 0 °C [32 °F] and 1013 mbar.



FM-200K-H

Float-Type Flow Meter Series FM®

Version FM-2K: heatable up to 180 °C,
Version FM-200K-H: electrically heated up to 180 °C
with needle valve at the inlet

Special Features

- Heatable version, max 180 °C [356 °F]
- Electrically heated version, max. 180 °C [356 °F]
- Needle valve integrated in the inlet
- Large scaling
- Reliable connection technique
- No cold bridges
- Integrated thermostat
- Status contact output
- Maintenance-friendly design
- Optionally with flow alarm FA

Application

The M&C flow meters FM-2K and FM-200K-H are used in analysis technique to control gas flow up to an operating temperature of 180 °C [356°F].

Six available measuring tubes and a floating ball out of glass cover a flow range from 16 to 800 NI/h.

The electrically heated sample lines type 3/4/5-N/M/H (see data sheet "Electrically Heated Sample Lines Type 3/4/5-N/M/H") are fixed with two mounting brackets.

Description

The M&C float-type flow meters FM-2K and FM-200K-H consist of an upright glass tube conically widening towards the top, in which a floating ball can move freely up and down. The medium flows from the bottom to the top through the tube and lifts the floating ball until there is a ring-shaped gap between the tube wall and the floating body so that the forces acting on the body are in equilibrium. Each height position of the floating body corresponds to a certain flow rate, which can then be read on a scale.

The FM-2K is the non-heated basic version for installation in heated systems. The FM-200K-H is supplied as an electrically completely heated version with integrated needle valve. It is mounted on a heat-decoupled mounting plate. Heating is provided by a high-performance heating element. The control temperature can be adjusted up to 180 °C [356 °F] via the integrated control thermostat with high-temperature limiter and low-temperature alarm contact.

The thermally insulated cover has an inspection window. Outside the cover, there is the electrical connection box with integrated thermostat and the optional flow monitoring, consisting of the sensor head FA2-H, fiber-optical light guide FO1 and the pre-amplifier K-FA-H. The required electronic controller FA-1... to be mounted externally must be ordered as an option. - See data sheet "Electronic Controller Series FA®" -

To avoid cold bridges, the connection fittings are also heated by means of two-part heat-conducting jaws.

Version FM-200K-H

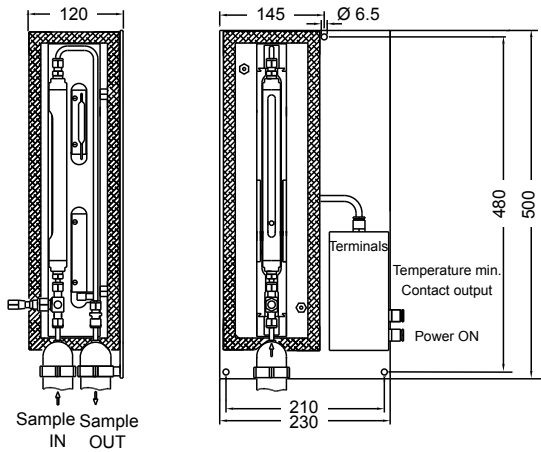

Version FM-200K-H/FA

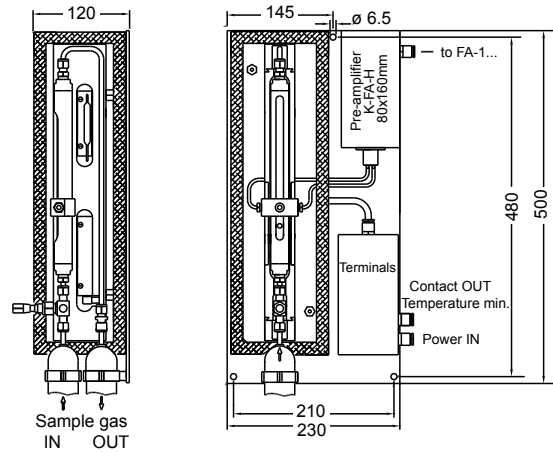

Heatable version FM-2K

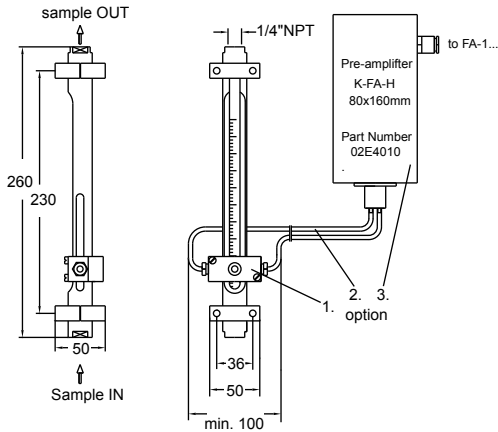

Optional flow monitoring

Dimensions in mm

Optional flow monitoring consisting of:

- | | | | |
|---|----------------------------|---------|--|
| 1 | Sensor head | FA2-H | 02E4002 |
| 2 | Fiber-optical light guides | FO1 | 02E4060/4065/4063 |
| 3 | Pre-amplifier | K-FA-H | 02E4010 |
| 4 | Electronic controller | FA-1... | 02E7300/7300b/7300d
02E7110/7110a/7110d |

Flow rate in NI/h air and differential pressure in mbar

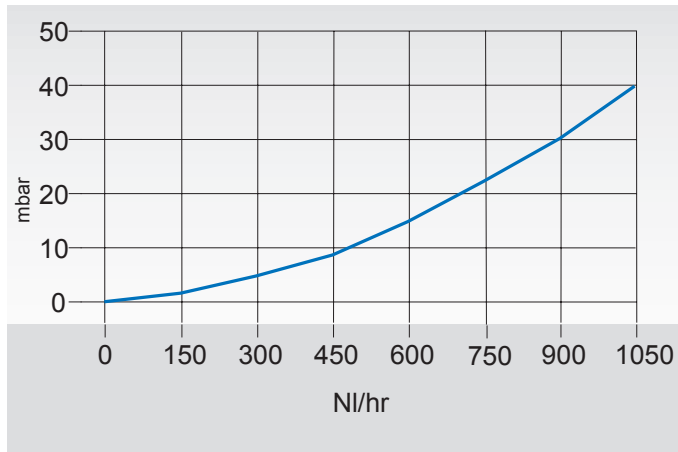

Technical Data



	FM-2K	FM-200K-H	FM-200K-H/FA
Part No.	09F2105	09F2505(a)	09F2555**
Heated/needle valve in the inlet	No	Yes	
Optical flow control, mono-stable**	No		Fix between 20-50 % of scale
Standard measuring range, at 1.2 bar, 20 °C [68 °F]	25 to 250 NI/h air		
Measuring ranges available	Scale: 1.6-16; 6-60; 10-100; 25-250; 50-500; 80-800 NI/h air, 1.2 bar, 20 °C [68 °F]		
Operating pressure/operating temperature	Max. 2 bar g/max. +180 °C [356 °F]		
Ambient temperature	-40 to +180 °C [-34 to 356 °F]	-25 to +60 °C [-13 to 140 °F]	-25 to +50 °C [-13 to 122°F]
Storage temperature	-40 to +80 °C [-34 to 176 °F]	-25 to +80 °C [-13 to 176 °F]	
Gas connections	1/4" NPT i	Tube fittings Swagelok® ø 6 mm, optional ø 1/4"	
Temperature controller		Capillary thermostat, integrated in electrical connection box with high-temperature limiter and low-temperature alarm contact	
Operating temperature		Adjustable from 0 to 180 °C [32 to 356 °F], factory-set at 180 °C [356 °F]	
Low-temperature alarm contact		alarm point ΔT 30 °C, change-over contact, voltage-free; contact rating 250 V, 3 A~, 0.25A =	
Power supply		230 V/50 Hz, 220 VA; optional 115 V/60 Hz (a)	
Electrical connections		Terminals 4 mm², 2 x cable glands PG13	
Protection/electrical standard		IP54 EN 60529/EN 61010, EN 60519-1	
Dimensions (W x H x D)	50 x 290 x 50 mm [≈ 2" x 11.4" x 2"]	250 x 500 x 140 mm [≈ 9.8" x 19.7" x 5.5"]	
Weight	0.8 kg [≈ 1.8 lbs]	8 kg [≈ 17.6 lbs]	8.5 kg [≈ 18.7 lbs]
Stagnant space/mounting	Approx. 6 cm³/wall-mounting		
Material of sample-contacting parts	Glass, stainless steel 316Ti, PTFE		

** The optical flow alarm is only equipped with pre-amplifier K-FA-H, the electronic controller must be ordered separately.

Please note: NI/h and NI/min refer to the German standard DIN 1343 and are based on these standard conditions: 0 °C [32 °F], 1013 mbar.

Swagelok® is registered trademark for fittings by Swagelok Company, USA.