

# Product Group Gas Dilution.

Product Category Gas Conditioning.





SP2000-H/DIL

## Gas Sample Probe Series SP®

Versions SP2000H/DIL and SP2000H320/DIL  
Gas Sample Dilution Probe

### Special Features

- Based on gas sample probe SP2000H
- Completely electrically heated up to 180 °C [356 °F] or 320 °C [608 °F]
- External critical orifice also heated
- Including a dilution gas pre-heater
- No dew point problems
- Dilution ratios from 10:1 up to 500:1
- With check gas connection at the probe
- Independent of the process temperature
- Smooth operation
- Straight maintenance

### Application

The electrically heated M&C gas sample dilution probe is used in processes where the measurement procedure or the handling of the process gas requires dilution of the measurement gas or the component(s) to be measured, e.g. in the case of extremely toxic gases, moisture measurement or emission measurement in flue gases.

Since the M&C dilution probe is based on the SP2000H gas sample probe, a variety of applications requiring special filter techniques, materials, etc. can be easily solved with this dilution probe.

### Description

The M&C gas sample probe SP2000H, which has proven itself in many applications, serves as the basis for the newly developed M&C dilution probe SP2000H/DIL.

In order to prevent the dew point from being undercut at the dilution point, the dilution unit with the critical orifice is installed in a temperature-stable manner in the heated part of the filter gas sample probe directly in the "clean gas outlet" and a gas pre-heater heats the dilution gas to probe temperature.

Test gas can be injected into the probe for analyzer calibration via the integrated test gas inlet connection. The probe is available with 180 °C [356 °F] or 320 °C [608 °F] heating. Optionally, the probe can be equipped with a manually operated, heated ball valve at the VA inlet to shut off the filter chamber from the sampling process when the filter is changed. A precision pressure regulator with pressure gauge is used to set the required dilution gas inlet pressure. The function check of the dilution injector is carried out by means of a vacuum manometer. The pressure regulator required for the dilution function and the pressure gauges must be ordered separately. The mounting set A is installed directly on the probe.

The control panel S for external mounting is additionally equipped with a shut-off valve and a flow meter for adjusting the test gas volume. Options A1 and S1 include an additional pressure regulator for the option bypass injector B or BR.

Dilution ratios from 10:1 to 500:1 can be achieved with the dilution probe. With high dilution factors, a correspondingly small amount of sample gas is extracted from the process. For this reason, a heated bypass injector integrated directly upstream of the dilution section is offered as an option to shorten the response time in vacuum operation: B without gas recirculation, BR with gas recirculation, and a bypass needle valve BV is used for bypass volume adjustment in over-pressure operation.

The design of the dilution device guarantees smooth operation and straightforward maintenance independent of the process temperature and pressure.

For further technical data, see data sheet for gas sample probe SP2000.

Gas Sample Dilution Probe Version SP2000H/DIL-VA

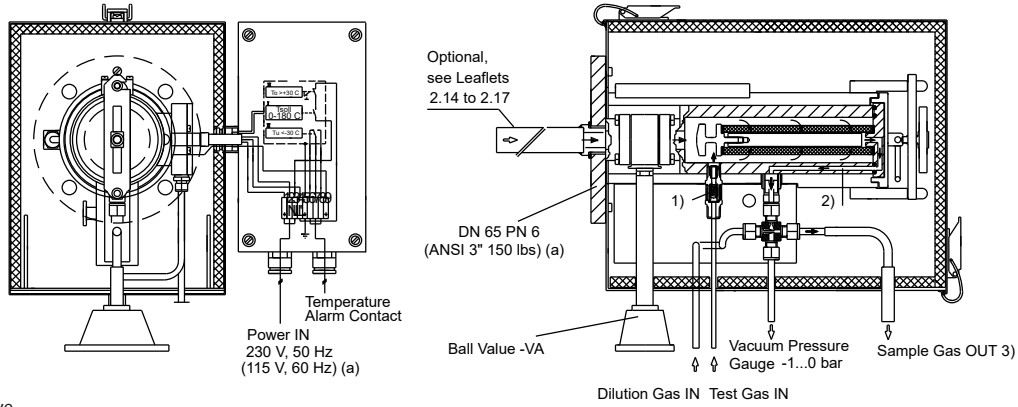

- 1) Calibration gas valve
- 2) Position of bypass connection
- 3) Tube  $\varnothing$  8 mm, (5/16") use at injector I tube connector 8 mm (5/16") and at II 8-12 mm (5/16-1/2")

Option A/A1 Pressure Control Set

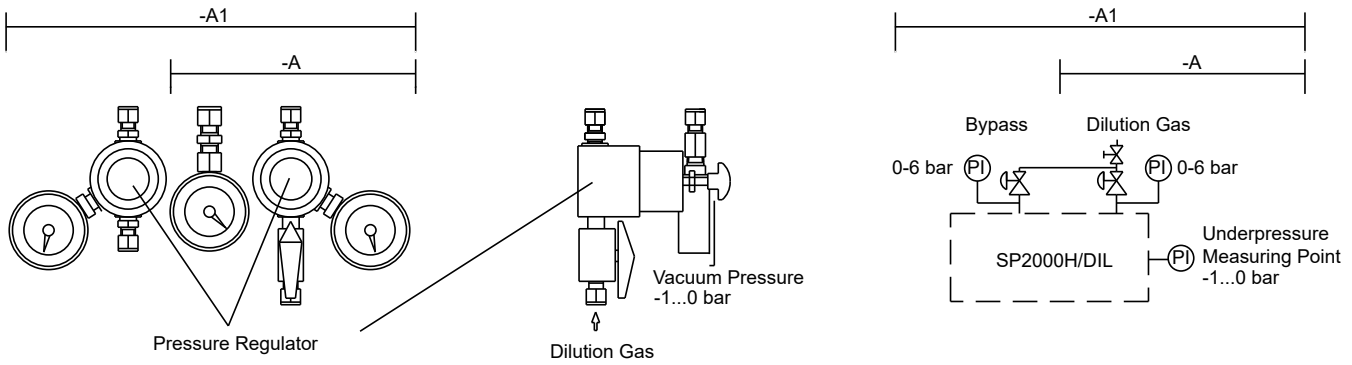

Option S/S1 External Control Panel

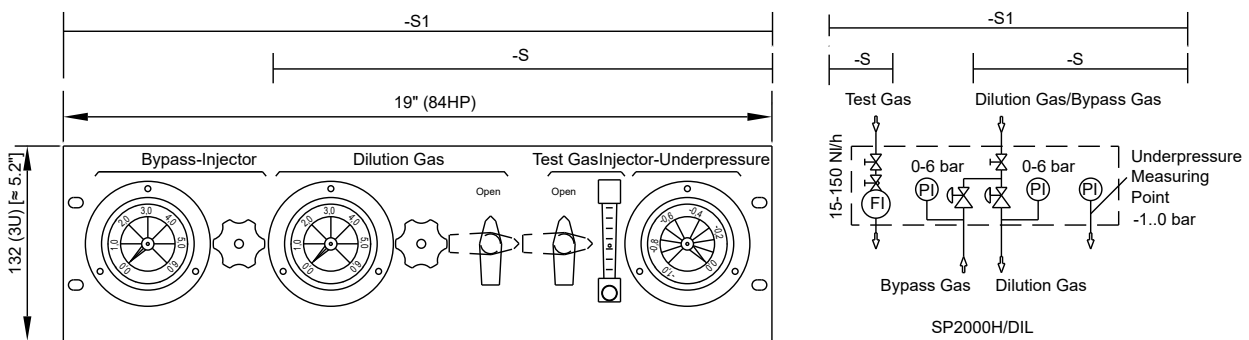

Gas connections:  
 Dilution gas, test gas, pressure control, bypass gas:  $\varnothing$  6 mm or on request 1/4" a  
 Sample gas out:  $\varnothing$  8 or 12 mm or on request  $\varnothing$  5/16" or 1/2" a

Dimensions in mm [Inches]

SP2000H/DIL

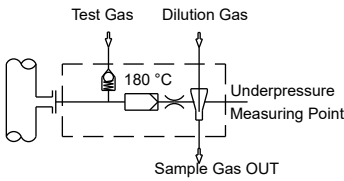

SP2000H320/DIL

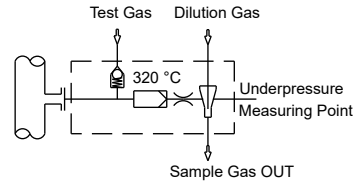

SP2000H/DIL-VA

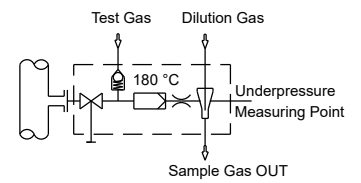

SP2000H/DIL-B\* BR\*

SP2000H/DIL-VA-B

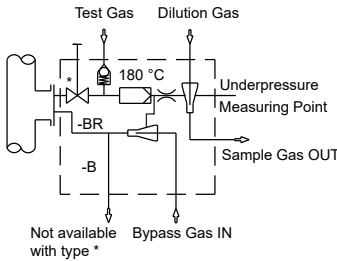

SP2000H/DIL-VA-BV

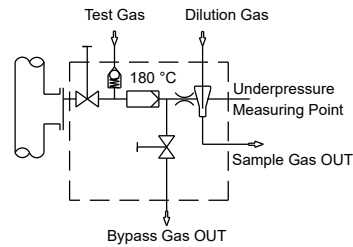

Technical Data

Series SP*	Version gas sample dilution probe SP2000H/DIL							
Sample tubes and pre-filters optional on request	See data sheets for sample tubes with G 3/4" connection thread and pre-filters with G 3/4" connection, with flange connection and with tube connection. See also data sheet „Electrically Heated Sample Probe Tube Series SP* Versions SP30-H, SP30-H1.1-V, SP35-H“.							
Dilution rates with the critical orifices "a" to "g" <sup>3)</sup>	a = 500	b = 200	c = 100	d = 50	e = 30*	f = 20	g = 10	: 1
Sample flow rate depending on the critical orifices "a" to "g"	a = 1.4	b = 2.7	c = 5.5	d = 11	e = 19*	f = 28	g = 55	l/h <sup>1)</sup>
Possibility to adapt the dilution factor	With dilution gas pressure adjustment -5 % to +30 % <sup>2)</sup>							
Dilution gas flow rate with injector version I or II	I: 480 to 600 l/h, optional for higher dilution rates II: 1800 to 3000 l/h							
Dilution gas pressure at inlet of pressure controller	Min. 4.5 bar g, max. 16 bar g							
Bypass injector B: gas pressure-gas flow rate-sample gas flow rate	At approx. 2 bar g - injector gas: approx. 300 NI/h - sample gas: approx. 150 NI/h							
Process pressure	0.9 up to 2 bar abs.							
Fault caused by process temperature variations	No fault, as operation is independent of process temperature							
Fault caused by process under- or overpressure	No fault as long as the differential pressure ΔP at the dilution unit is > 0.5 bar g and test gas is injected to the probe under process conditions							
Fault caused by atmospheric pressure variations	< 1 % with a variation of 50 mbar							
Materials in contact with the sample gas	Stainless steel 316L/316Ti, quartz glass, FKM, graphite							
Weight	Approx. 20 kg (≈ 44.1 lbs)							

\*Standard, others to be indicated when ordering, intermediate values possible. 1) approx. at 3 bar dilution gas downstream pressure controller. 2) -5 % not possible for orifice "g" 3) with injector version I. Further technical data, see data sheet for gas sample probe SP2000.

Please note: NI/h and NI/min refer to the German standard DIN 1343 and are based on these standard conditions: 0 °C [32 °F], 1013 mbar.

Part No.	Type	M&C gas sample dilution probe SP2000H/DIL with orifice 'e' for dilution ratio 30 : 1 standard
20S4002(a)	SP2000H/DIL	Dilution probe 180 °C [356 °F] without ball valve at the inlet
20S4102	SP2000H320/DIL	Dilution probe 320 °C [608 °F] without ball valve at the inlet
20S4005	SP2000H/DIL-VA	Dilution probe 180 °C [356 °F] with heated manually operated ball valve at the inlet
20S4022(a)	SP2000H/DIL-B	Dilution probe SP2000H/DIL with bypass injector, without integrated gas recirculation
20S4024(a)	SP2000H/DIL-BR	Dilution probe SP2000H/DIL with bypass injector and bypass recirculation
20S4026	SP2000H/DIL-VA-B	Dilution probe SP2000H/DIL-VA with bypass injector, without integrated gas recirculation
20S4030	SP2000H/DIL-VA-BV	Dilution probe SP2000H/DIL-VA with bypass-needle valve, without integrated gas recirculation
20S4200	SP2000H/DIL-A	Option: add-on set with 1 pressure controller, 2 pressure gauges, mounting set incl. fittings for dilution probe
20S4210	SP2000H/DIL-A1	Option: add-on set with: 2 pressure controllers, 3 gauges, mounting set incl. fittings for dilution probe with bypass
20S4250	SP2000H/DIL-S	Option: control panel with 1 pressure controller, 2 pressure gauges, flow meter, 2 shut-off valves
20S4260	SP2000H/DIL-S1	Option: control panel with 2 pressure controllers, 3 pressure gauges, flow meter, 2 shut-off valves

Please add an "a" to the Part No. for dilution probe with 115 V/60 Hz power, mounting flange ANSI 3" 150 lbs or for connectors with inches dimensions.

Part No. 20S4300: complete set critical orifice a to g, injector orifice II, orifice seals

Control panel S, S1 incl. wall-mounting housing optional available: S-G, S1-G.

Other versions on request.



SP2000-H/GVW1

## Gas Pre-Heater Series SP®

Version SP2000-H/GVW1(2)

### Special Features

- Prevents temperature drop below the dew point inside the probe
- Factory assembly
- 2 variants with one or two paths

### Application

The M&C GVW1(2) gas pre-heater is used to pre-heat the backpurging or dilution gas of gas sample probes of the SP2000 series in order to prevent possible cooling down inside the gas sample probe. Subsequent problems related to temperatures drops below the dew point resulting in malfunction and corrosion are thus avoided.

### Description

The M&C gas pre-heaters GVW1(2) consist of heat exchanger plates made of stainless steel and can be directly mounted to the heating system of the sample probe series SP2000-H.

The pre-heater type GVW2 is especially designed for the dilution probes SP2000-H/DIL. With its two gas paths, dilution gas as well as bypass gas can be pre-heated to achieve faster response times.

The optional backpurging connection to the probe of series SP2000-H is ensured via a 6-mm-tube (standard).

## Dimensions

## GVW1

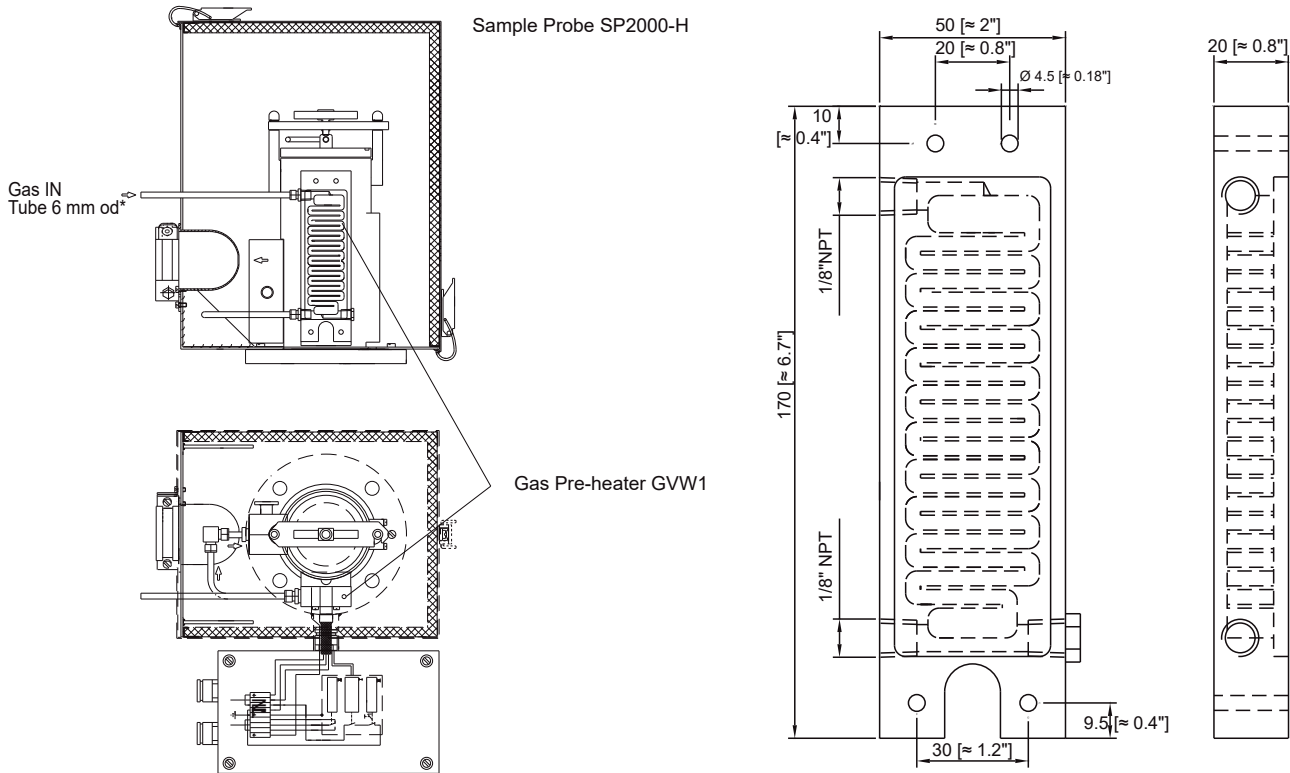

## GVW2

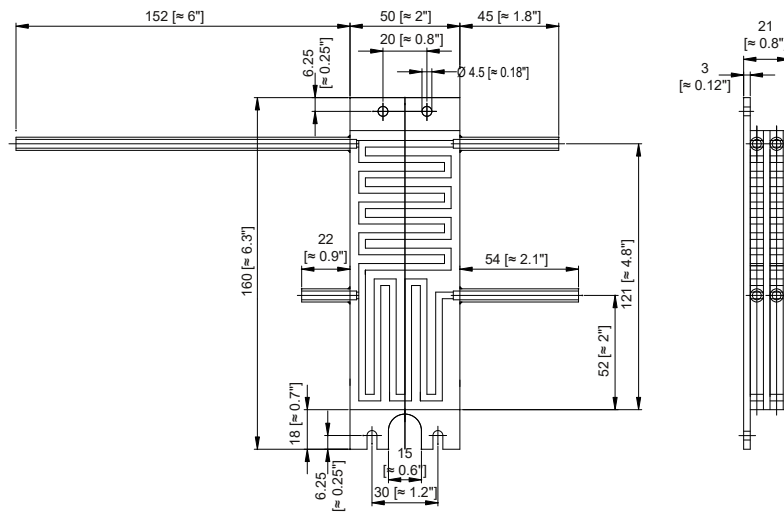

Dimensions in mm [Inches]

## Technical Data

	Version GVW1	Version GVW2
Part No.	20S9058	20S9060
Material	Stainless steel SS 316Ti	
Operating temperature max.	350 °C [662 °F]	
Operating pressure max.	6 bar g	
Flow rate max.	-R, 2 bar inlet pressure: 3.0 m <sup>3</sup> /h, with constant outlet temperature	
(GVW2 1/2 value per gas path)	-R, 6 bar inlet pressure: 8.5 m <sup>3</sup> /h, with outlet temperature drop of 10 °C in 1 min	
Gas connections	GVW1: 1/8" NPT i, GVW2: 6-mm-tube	
Option	SP2000-H/GVW, Part No. 20S9062 connection from the pre-heater GVW1 to the backpurging/calibration gas valve /R and gas inlet via 6-mm-tube made of SS 316Ti .	



DIL-1/H

## Gas Dilution Unit DIL-1/(H)

### Special Features

- Well-proven M&C dilution technique
- Operation at ambient temperature
- Optionally heated to 180 °C [356 °F] or 320 °C [608 °F]
- Integrated dilution pre-heater
- No dew point problems
- Dilution ratios from 10:1 to 500:1
- With test gas connection
- Independent of the ambient temperature
- Smooth operation
- Straightforward maintenance

### Application

The non-heated or electrically heated M&C dilution unit DIL-1/(H) is used in analytical technology for processes in which the measuring method or the handling of the process gas requires dilution of the measuring gas or the component(s) to be measured, e.g. extremely toxic gases, moisture measurement or emission measurement.

The dilution unit is based on the functional dilution technology which has proven itself for years in the M&C gas sample probe SP2000-H/DIL.

### Description

The M&C dilution units DIL are mounted on a plate for wall-mounting. The operating temperature of the non-heated version DIL-1 corresponds to the ambient temperature. The DIL-1/H version is heated to 180 °C [356 °F] and equipped with a thermally insulated cover 320 °C [608 °F] version on request).

The temperature is controlled by an integrated capillary sensor thermostat, adjustable from 0 to 180 °C [0 to 356 °F], including high temperature limiter and low temperature alarm.

The heated lines are connected without cold bridges in the heated section. Before entering the dilution unit, the dilution gas is heated to operating temperature by a gas pre-heater. Internal protective filters are provided for the sample gas and dilution gas to protect the dilution unit from contamination. For analyzer calibration, test gas can be supplied at the integrated test gas connection.

A precision pressure regulator with pressure gauge is used to set the required dilution gas inlet pressure. The function check of the dilution injector is carried out by means of a vacuum pressure gauge.

Pressure regulators and pressure gauges must be ordered separately and are available in 2 versions: The add-on set A (A1) for direct installation on the mounting plate and the control panel S (S1) for external 19" rack-mounting including shut-off valve and flow meter to adjust the test gas volume.

Dilution ratios from 10:1 to 500:1 can be realized with the dilution unit. With high dilution factors, a correspondingly small amount of sample gas is extracted from the process. An optional bypass injector (B) integrated directly upstream of the dilution section is therefore available to shorten the response time in operation with atmospheric pressure or in vacuum operation (option 1).

In the case of option 1, both mounting versions A1/S1 include the additional pressure regulator.

The design of the dilution unit guarantees smooth operation and straightforward maintenance independent of the process temperature.

DIL-1 with control panel -S (S.1)

Electrically heated Gas-Dilution Unit DIL-1/H with control panel -S (S.1)

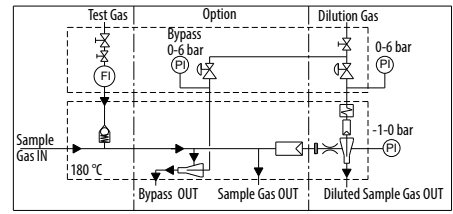
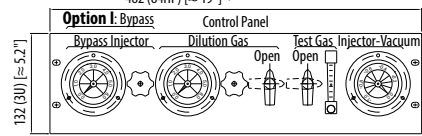
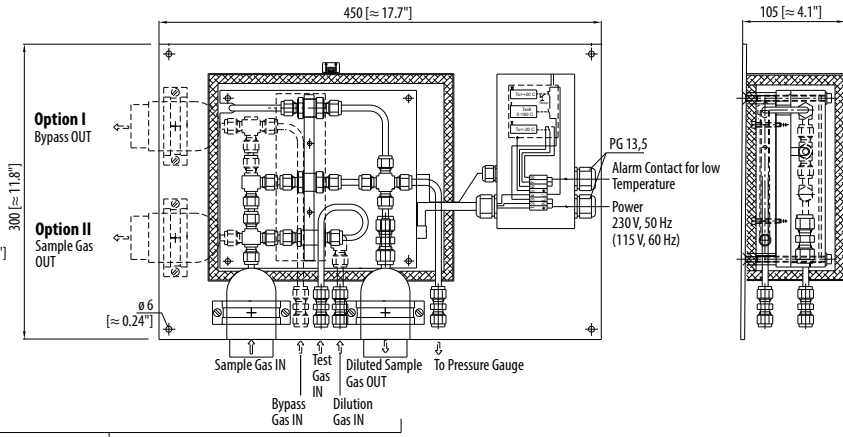
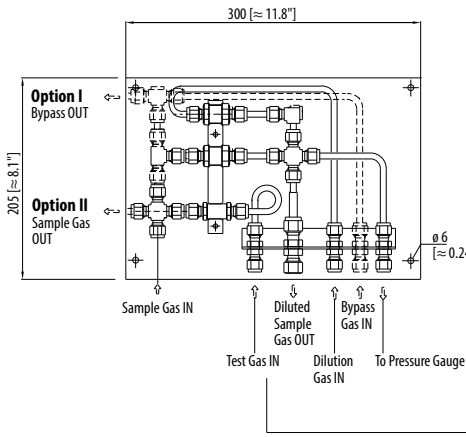

Gas-Dilution Unit DIL-1 with mounting set -A (-A1)

Electrically heated Gas-Dilution Unit DIL-1/H with mounting set -A (-A1)

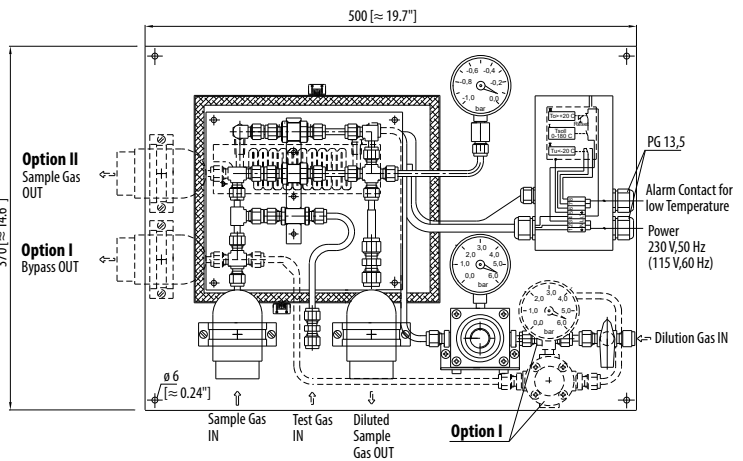
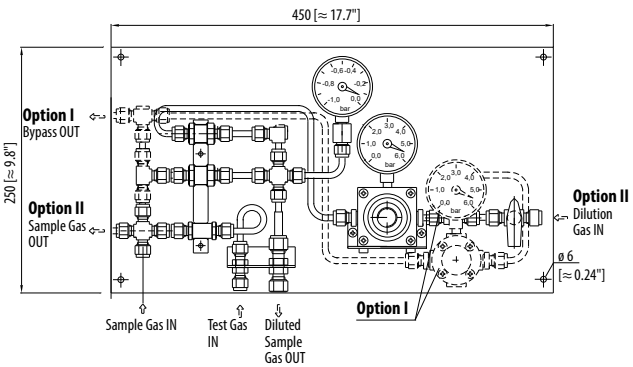

Gas conections:  
Diluted Sample Gas OUT for tube 8 x 1 mm  
All other connections for tube 6 x 1 mm

Connections in inches on request

Dimensions in mm [Inches]



M&C Dilution Unit DIL-1/(H)	
Dilution rates with the critical orifices 'a' to 'g'	a = 500    b = 200    c = 100    d = 50    e = 30*    f = 20    g = 10    : 1
Sample flow rate depending on the critical orifices 'a' to 'g'	a = 1.4    b = 2.7    c = 5.5    d = 11    e = 19*    f = 28    g = 55    l/h <sup>1)</sup>
Possibility to adapt the dilution factor	With dilution gas pressure adjustment -5 % to +30 % <sup>2)</sup>
Dilution gas flow rate with injector version 1 or 2	Version 1: 480 to 600 NI/h, version 2: 1800 to 3000 NI/h
Dilution gas pressure at the inlet of pressure regulator	Min. 4.5 bar g, max. 16 bar g
Bypass injector/B inlet pressure/gas consumption sample gas flow rate	Approx. 2 bar injector gas approx.: 300 l/h, sample gas: approx. 150 l/h
Process pressure	0.9 to 2 bar abs.
Fault caused by process temperature variations	Operation independent of process temperature
Fault caused by process low- or overpressure	No fault as long as the differential pressure $\Delta P$ at the dilution unit is > 0.5 bar g and test gas is injected to the probe under process conditions
Fault caused by atmospheric pressure variations	< 1 % with a variation of 50 mbar
Materials in contact with the sample gas	Stainless steel 316L/316Ti, quartz glass, FKM, graphite
Power supply for DIL-1/H	230 V/50 Hz, 800 W
Temperature controller for DIL-1/H	Capillary thermostat adjustable from 0 to 180 °C [32 to 356 °F], with high temperature limiter and low temperature alarm as changeover contact, voltage-free, alarm point $\Delta T_{30} \text{ °C}$ to $T_{SET}$ , contact rating max. 250 V 3 A AC, 0.25 A DC
Weight	Approx. 8 kg [≈ 17.6 lbs]

\* Standard, others to be indicated when ordering, intermediate values possible.

1) approx. at 3 bar dilution gas.

2) -5 % not possible for orifice 'g'.

Please note: NI/h and NI/min refer to the German standard DIN 1343 and are based on these standard conditions: 0 °C [32 °F], 1013 mbar.

Part No.	Type	M&C-Dilution Unit DIL-1/(H) with orifice 'e' for dilution ratio 30-40:1 (standard)
20S4900	DIL-1	Dilution unit type DIL-1, non-heated, installed on a mounting plate, dilution ratio: 30-40:1 (standard), consisting of: dilution section, 2 filters for sample gas and dilution gas, check valve for calibration gas
20S4905(a)	DIL-1/H (a)	Dilution unit electrically heated to 180 °C [356 °F], (a) to be added to the Part No. for power 115 V/60 Hz
20S4925	Option 1: DIL-1/B	DIL-1/B, additional bypass injector to reduce the response time in the case of high dilution ratios, bypass injector B
20S4930	Option 2: 2xOUT	Additional sample gas outlet undiluted
20S4205	DIL-1/A	Option: add-on set: 1 pressure regulator, 2 pressure gauges, mounting kit for dilution unit
20S4215	DIL-1/A1	Option: add-on set: 2 pressure regulators, 3 pressure gauges, mounting kit incl. fittings for dilution unit with bypass injector
20S4250	DIL-1/S	Option: control panel with 1 pressure regulator, 2 pressure gauges, 1 flow meter, 2 ball valves
20S4260	DIL-1/S1	Option: control panel with 2 pressure regulators, 3 pressure gauges, 1 flow meter, 2 ball valves
20S4206	DIL-1/A-FM	Option: add-on set: 1 pressure regulator, 2 pressure gauges, 2 ball valves, 1 flow meter
20S4216	DIL-1/A1-FM	Option: add-on set: 2 pressure regulators, 3 pressure gauges, 2 ball valves, 1 flow meter

Other versions upon request.